

HIGHLY  
SECURE  
VANDAL RESISTANT

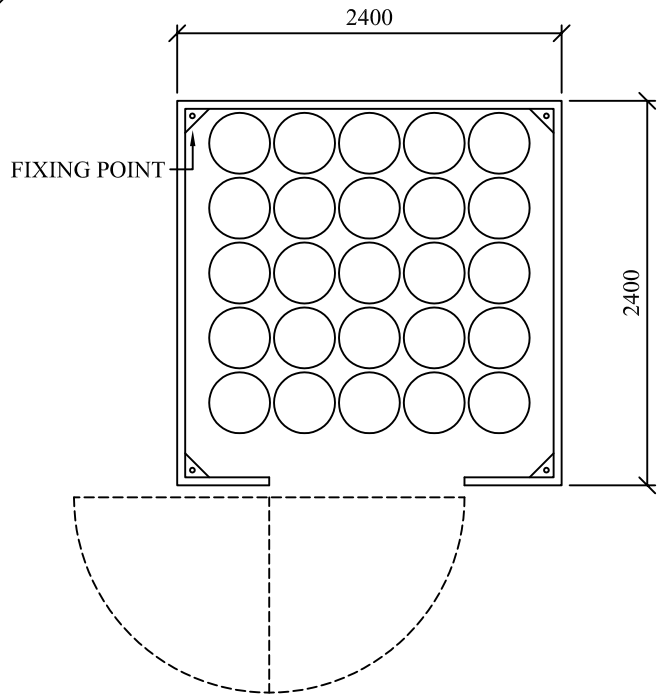

PLAN

ZINC PHOSPHATE  
PAINT FINISH

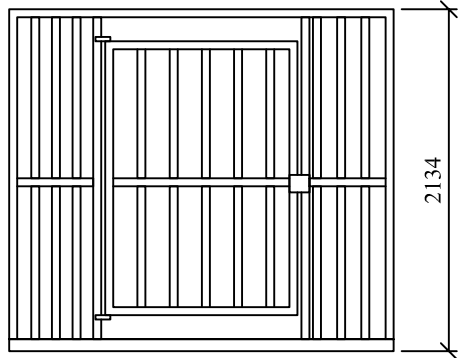

FRONT ELEVATION

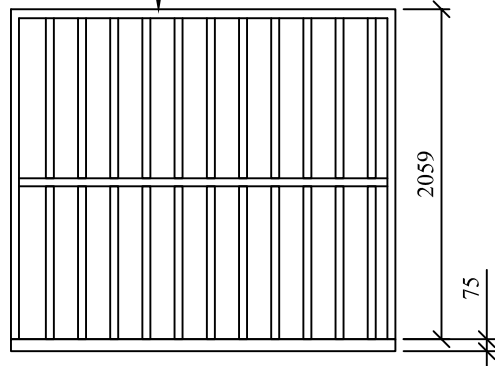

SIDE ELEVATION

DO NOT SCALE REMOVE ALL BURRS AND SHARP EDGES	 THIRD ANGLE PROJECTION	REV No	DATE		BY	CUSTOMER	<b>CLEVELAND SITESAFE LIMITED</b>  <small>RIVERSIDE WORKS CLEVELAND TS3 RAT 01642 244663</small>	DRAWN JWH	DESCRIPTION GAS BOTTLE CAGE FOR APPROX 25 BOTTLES  DRG No GASB25WEB2009
		REV 1						SCALE	
		REV 2						DATE	
		REV 3						15/07/2009	
		REV 4							